

M18FBLG3-802 GEN3 SNG BATTERY BLOWER IN2

4933493302 - M18FBLG3-802 - 4000503322

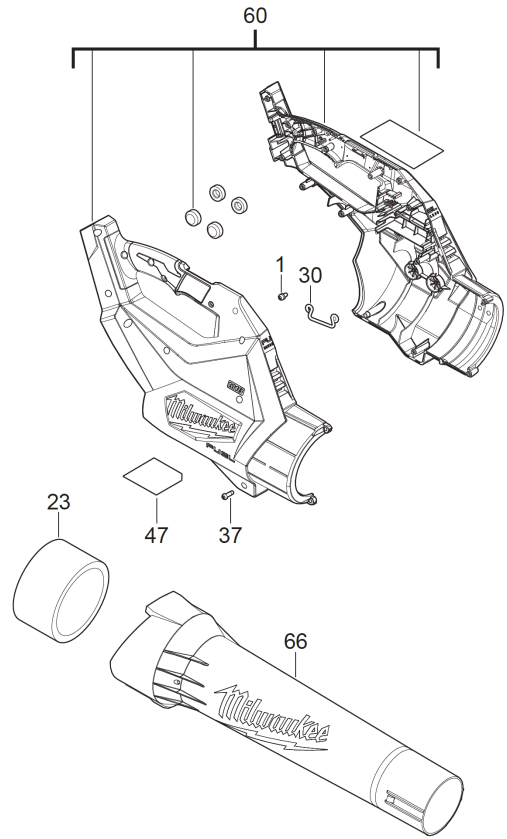

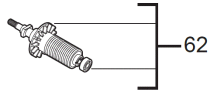
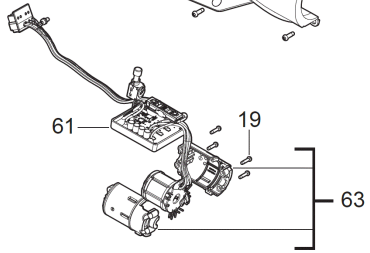
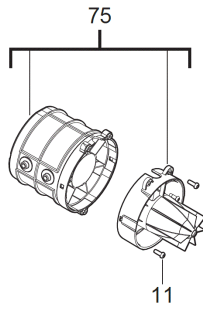
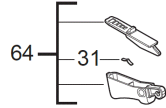
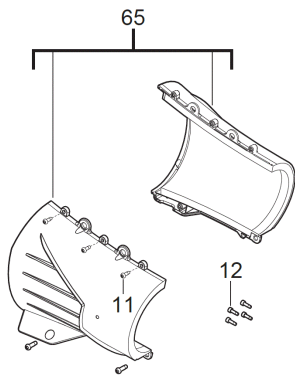
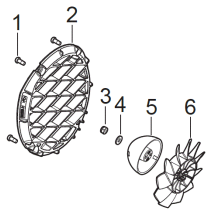

Position	Quantity	Description	Part number	EAN
0001	5	SCREW	4931435015	4002395856633
0002	1	COVER	4931496840	4058546539771
0003	1	NUT	4931453988	4002395280551
0004	1	WASHER	4931496841	4058546539788
0005	1	CAP	4931496842	4058546539795
0006	1	FAN	4931496843	4058546539801
0011	6	SCREW	4931447515	4002395880539
0012	4	SCREW	4931496844	4058546539818
0019	4	SCREW	4931453227	4002395153206
0023	1	FOAM SLUG	4931496845	4058546539825
0030	1	WIRE	4931496490	4058546536275
0031	1	SPRING PLATE	4931452341	4002395172528
0037	16	SCREW	4931479948	4058546397111
0047	1	RATING PLATE	4931496846	4058546539832
0060	1	HOUSING	4931496847	4058546539849
0061	1	ELECTRONIC	4931496848	4058546539856
0062	1	ARMATURE	4931496849	4058546539863
0063	1	MOTOR HOUSING	4931496850	4058546539870
0064	1	TRIGGER	4931496851	4058546539887
0065	1	HOUSING	4931496852	4058546539894
0066	1	TUBE	4931496853	4058546539900
0075	1	HOUSING	4931496854	4058546539917